

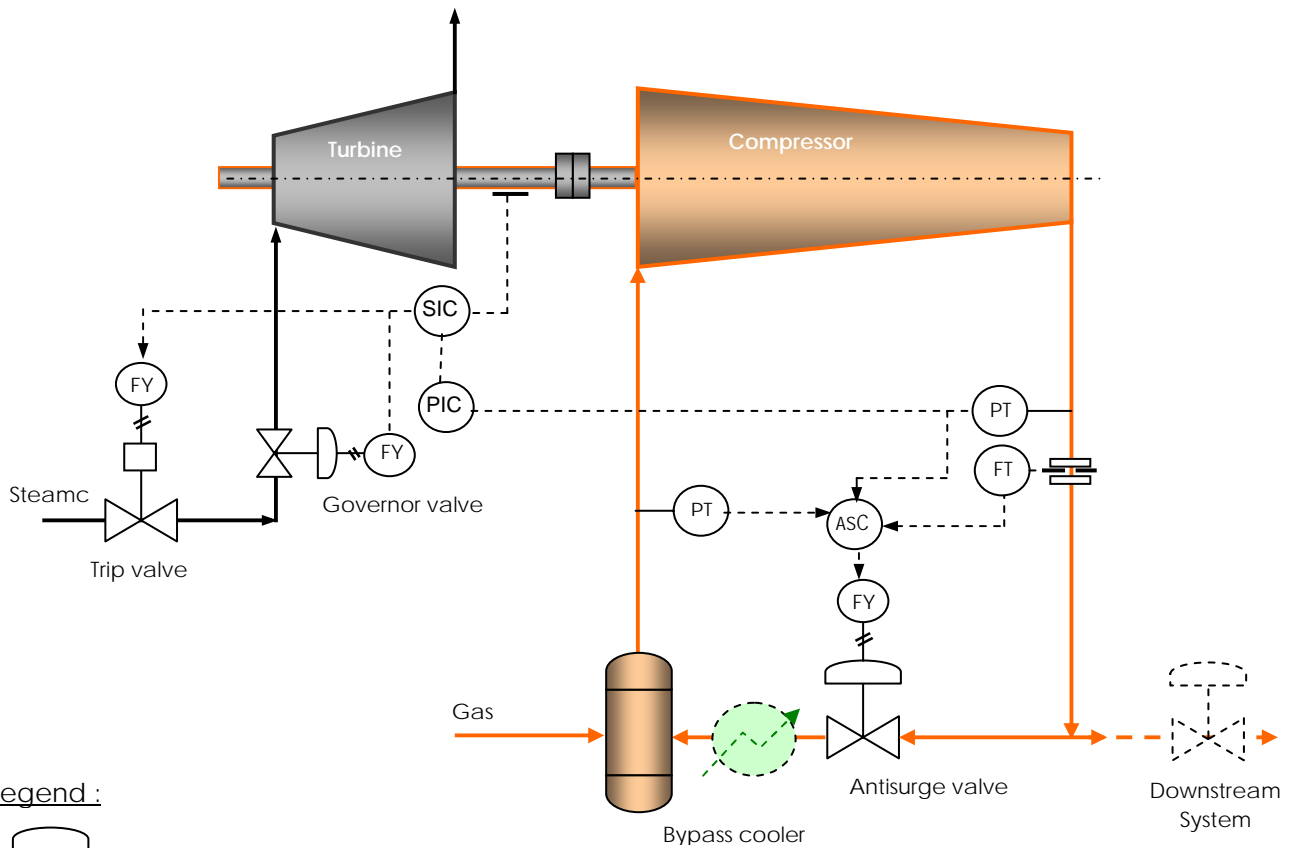

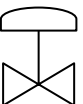





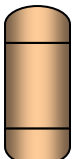

# COMPRESSOR CONTROLLER

## 1. PRESSURE CONTROL ONLY



### Legend :

-  Control valve
-  Pressure transmitter
-  Flow transmitter
-  Antisurge controller
-  Drum
-  Cooler
-  Non return valve
-  Flow element

-  SIC Speed indicator controller
-  PIC Pressure indicator controller

In pressure control, capacity will be controlled by system. Pressure to be controlled by speed of driver. If capacity decrease, speed will also decrease at the same pressure. And if capacity increase, speed will also increase at the same pressure, but speed is limited by SIC to protect equipments from overspeed such as alarms and trip.

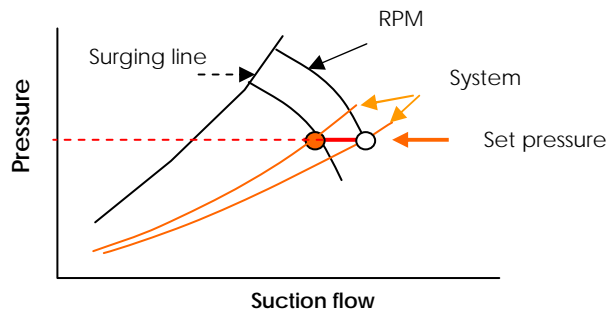

## 2. CAPACITY CONTROL ONLY

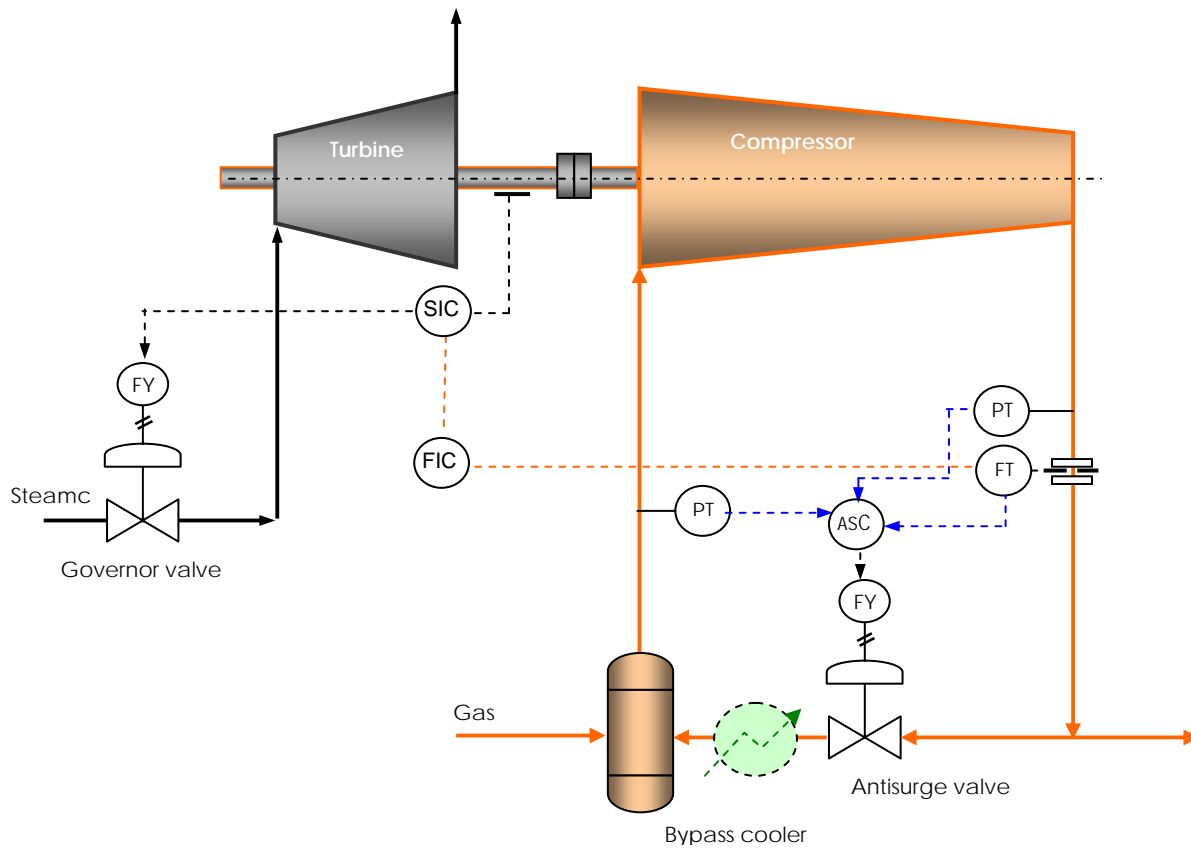

In this control, the system has fix characteristic curve. Pressure doesn't controlled. If capacity is setted to lower flow (by FIC), speed will decrease at the same system characteristic curve. And if capacity is setted to higher flow, speed also will increase but limited by SIC to protect equipment from over speed. High or low speed alarms are setted at LPA/HPA. To protect from over pressure, equipment such as relieve valve may be used.

Instead of FIC, capacity may also controlled from SIC by increasing or decreasing turbine speed. In this case FIC can be replaced by flow indicator (FI) only.

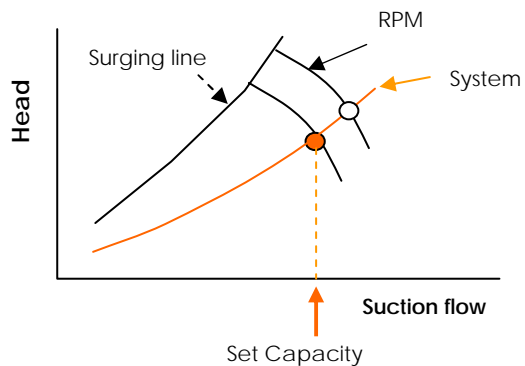

Note :

1. Indicators and alarms are not shown in this diagram

### 3. CAPACITY CONTROL FOR COMPRESSOR DRIVEN BY MOTOR DRIVER (constant speed)

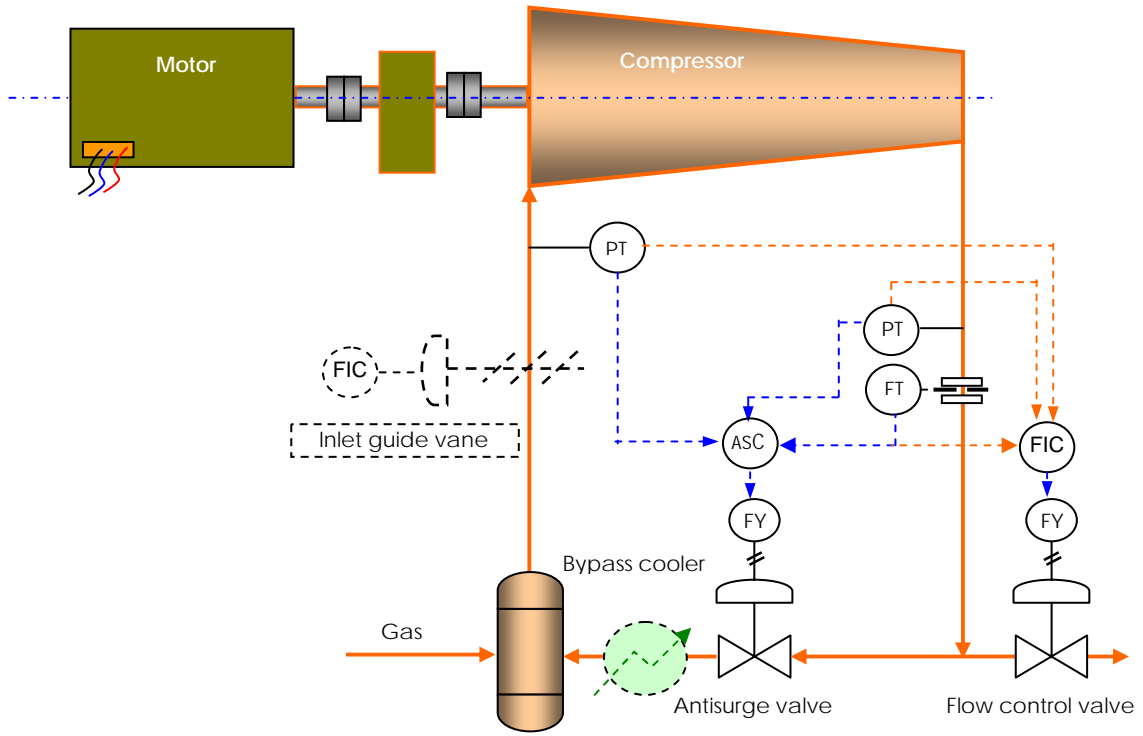

Capacity is controlled by FIC and flow control valve. If capacity is setted to lower flow, control valve will be to closer position and making new characteristic curve and cross head vs capacity curve at higher pressure. And if capacity set to more flow, pressure will also decrease.

Capacity control is also can be done by inlet guide vanes (IGV) without flow control valve.

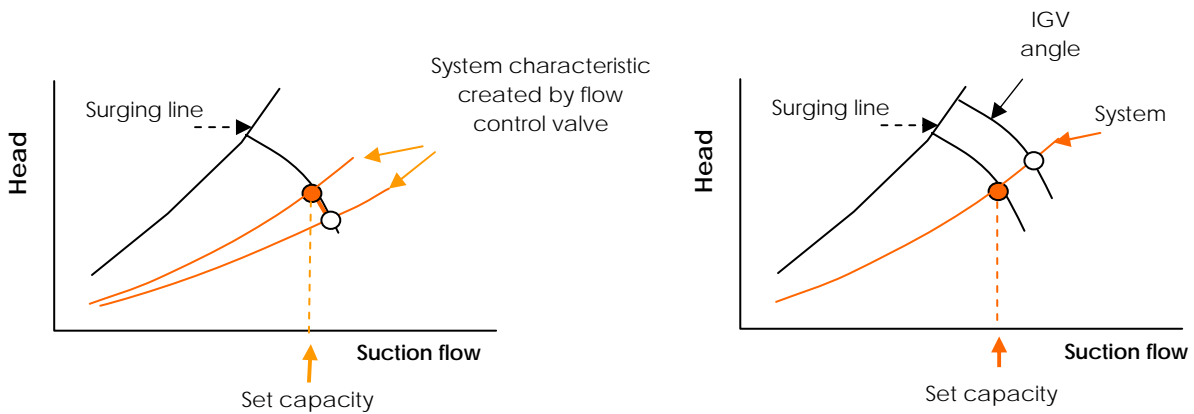

Capacity controlled by control valve

Capacity controlled by IGV

#### 4. GAS INLET TEMPERATURE, DISCHARGE PRESSURE AND SPEED CONTROL

##### 4.A. Gas Inlet Temperature and Discharge Pressure Control (motor driver)

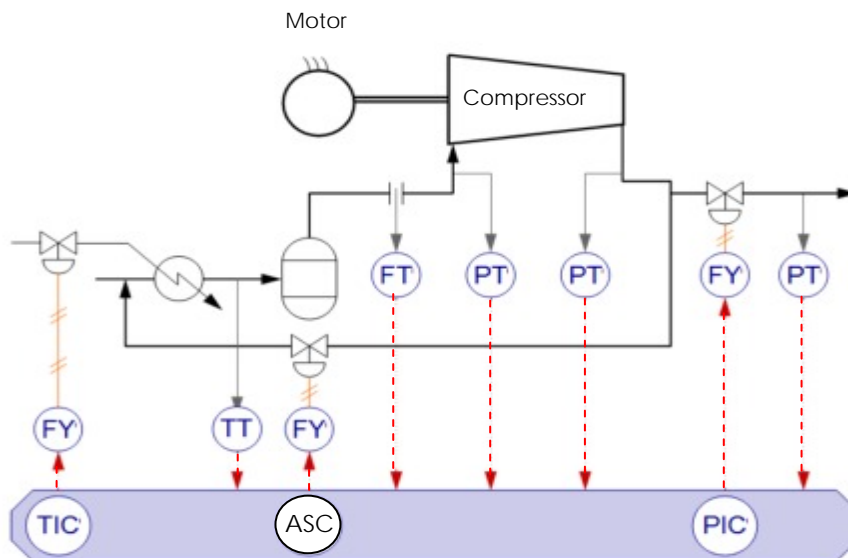

##### 4.B. Gas Inlet Temperature, Discharge Pressure and Speed Control (turbine driver)

